

AK/AK-B Series

Frame Size 24mm/42mm/60mm/85mm Shaft Type Motor Frame Size 42mm/60mm/85mm Shaft Type+Built-in brake type Motor

■ Features

- Compact design and light weight with high accuracy, speed and torque
- Suitable for small-sized equipment applications
- Frame size 42mm/60mm/85mm built-in brake of shaft type for compact equipment (AK-B Series)
- Brake force is released (AK-B Series) when applying power on brake wire
- Cost-effective

Line-up

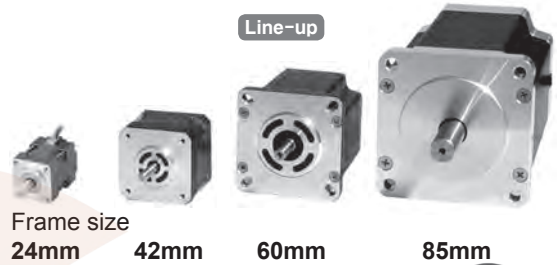

⚠ Please read "Caution for your safety" in operation manual before using.

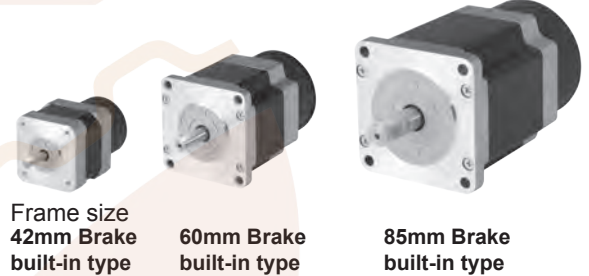

■ Dimensions

- ※These dimensions are for dual shaft models. Single shaft models do not include shafts indicated in the dotted lines.
- ※For flexible coupling (ERB Series) information, refer to F-64. (frame size 24mm, 48mm, 60mm (Shaft type))
- ※Brake is non-polar and be sure to observe rated excitation voltage (24VDC). (Except frame size 24mm)
SW1 ON : Brake Release / SW1 OFF : Brake Execute

◎ Frame size 24mm

(unit: mm)

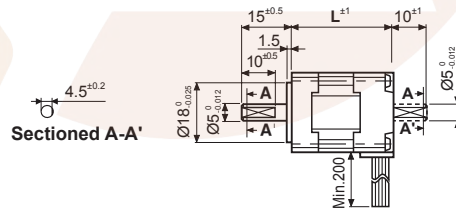
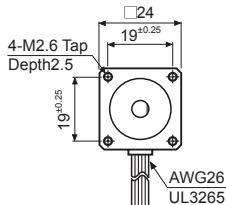

(unit: mm)

Model	L
02K-S523(W)	30.5
04K-S525(W)	46.5

◎ Frame size 42mm

(unit: mm)

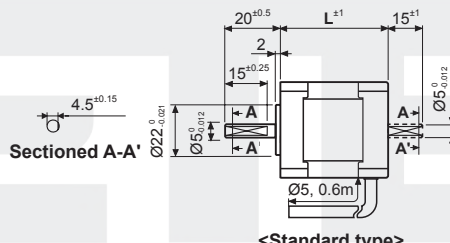
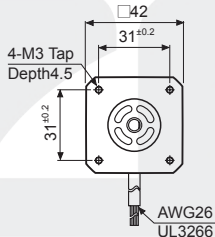

(unit: mm)

Model	L
A1K-S543(W)-[B]	33
A2K-S544(W)-[B]	39
A3K-S545(W)-[B]	47

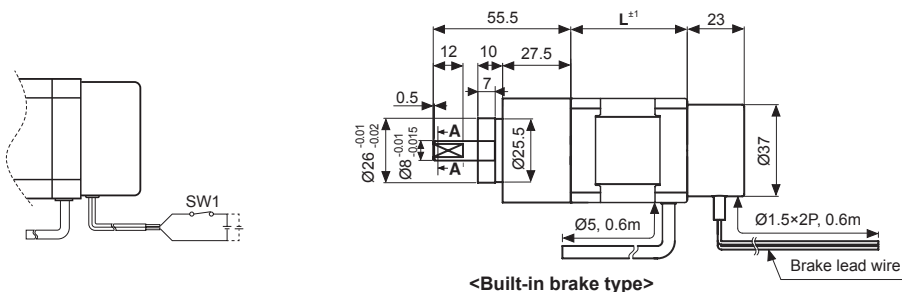

5-Phase Stepper Motor

■ Dimensions

◎ Frame size 60mm

(unit: mm)

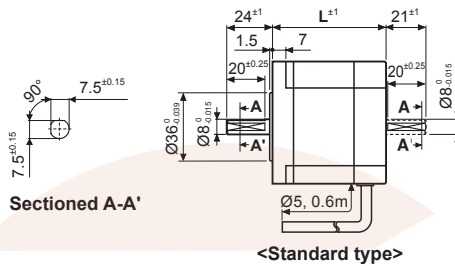
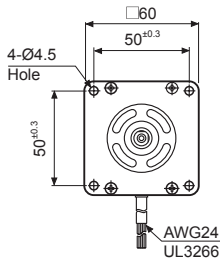

Model	L
A4K-□564(W)-□B	48.5
A8K-□566(W)-□B	59.5
A16K-□569(W)-□B	89

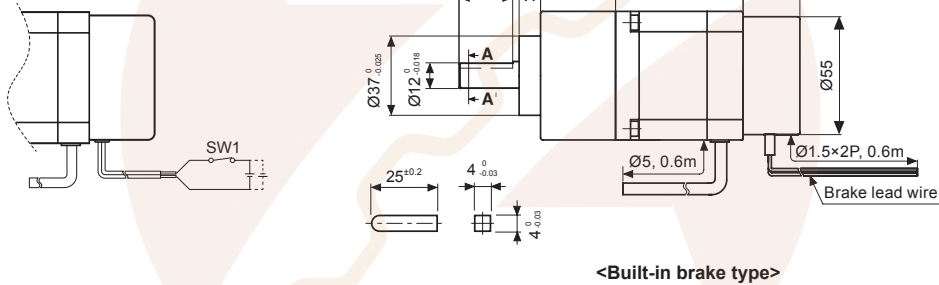

◎ Frame size 85mm

(unit: mm)

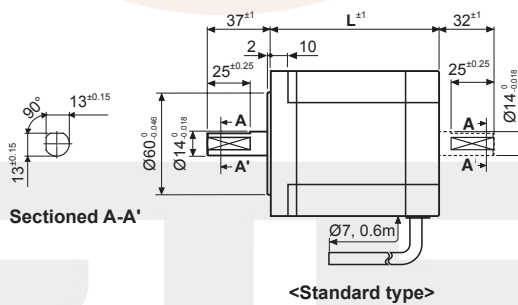
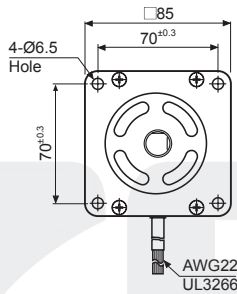

Model	L
A21K-□596(W)-□B	68
A41K-□599(W)-□B	98
A63K-□5913(W)-□B	128

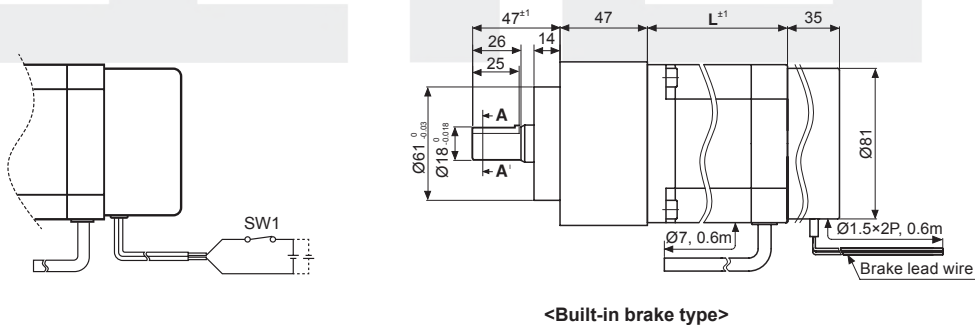

(A) Photoelectric Sensors

(B) Fiber Optic Sensors

(C) Door/Area Sensors

(D) Proximity Sensors

(E) Pressure Sensors

(F) Rotary Encoders

(G) Connectors/ Sockets

(H) Temperature Controllers

(I) SSRs / Power Controllers

(J) Counters

(K) Timers

(L) Panel Meters

(M) Tacho / Speed / Pulse Meters

(N) Display Units

(O) Sensor Controllers

(P) Switching Mode Power Supplies

(Q) Stepper Motors & Drivers & Controllers

(R) Graphic/ Logic Panels

(S) Field Network Devices

(T) Software

AK/AK-B Series

Characteristic

• 02K-S523

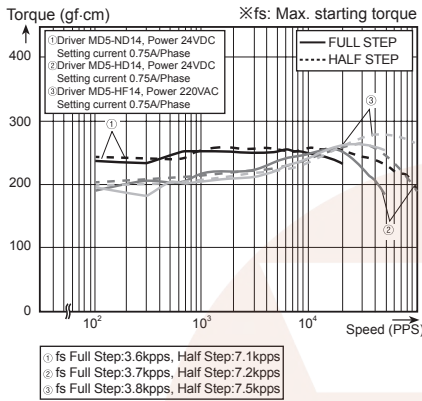

• 04K-S525

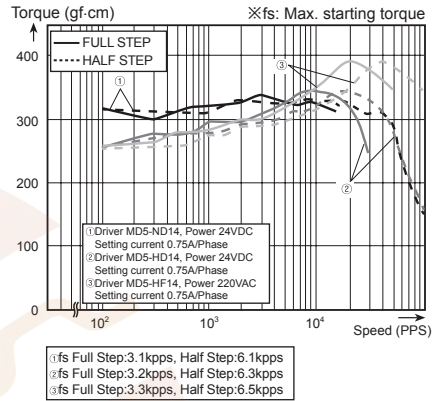

• A1K-S543 / A1K-S543-B

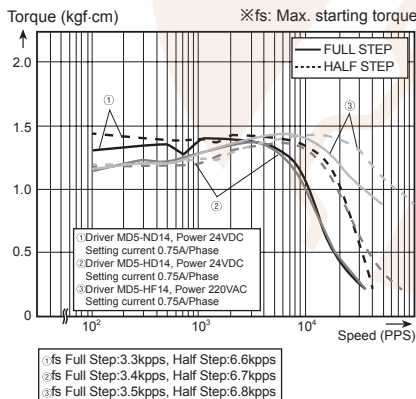

• A2K-□544 / A2K-□544-B

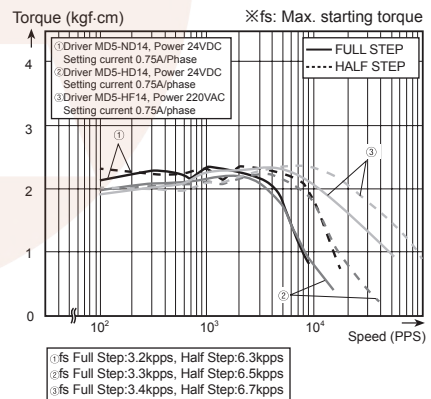

• A3K-S545 / A3K-S545-B

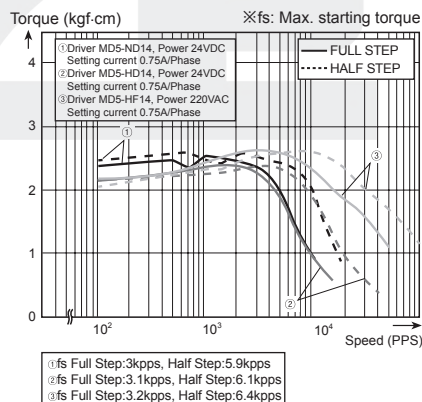

• A4K-□564 / A4K-M564-B

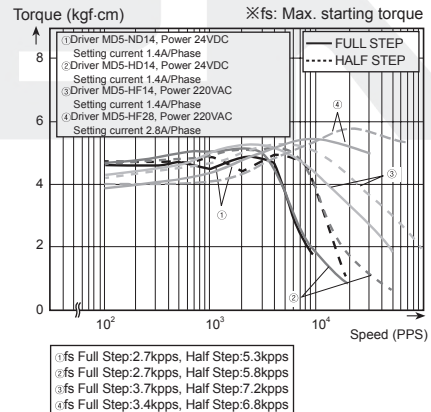

5-Phase Stepper Motor

Characteristic

● A8K-566 / A8K-M566-B

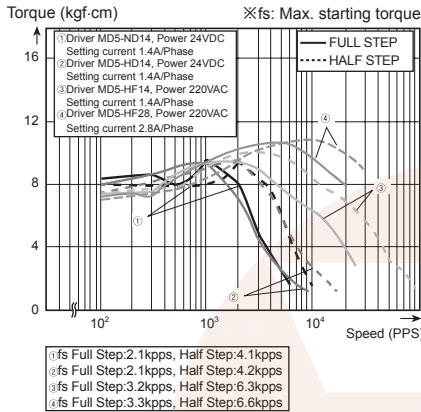

● A16K-569 / A16K-569-B

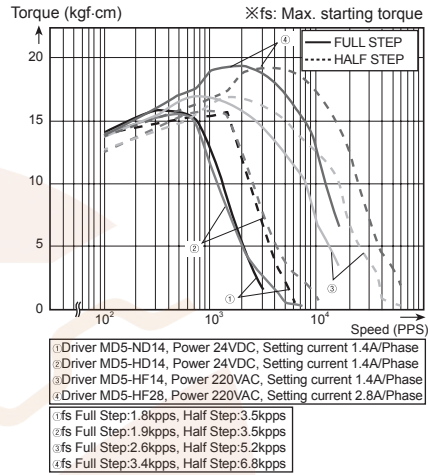

● A21K-596 / A21K-596-B

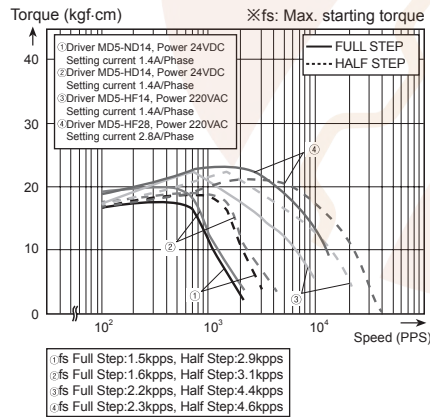

● A41K-599 / A41K-599-B

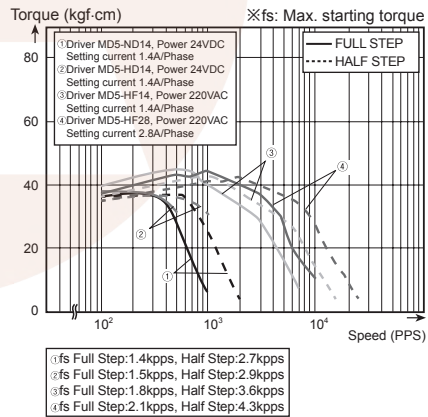

● A63K-5913 / A63K-5913-B

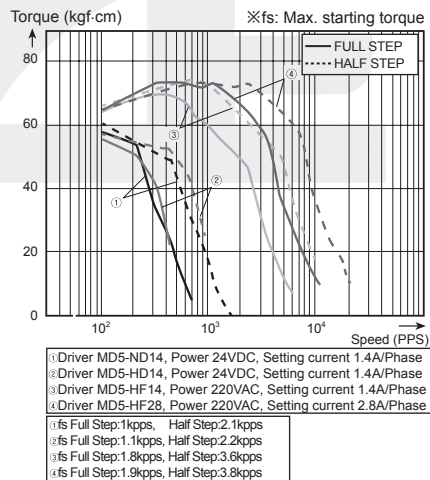

(A) Photoelectric Sensors

(B) Fiber Optic Sensors

(C) Door/Area Sensors

(D) Proximity Sensors

(E) Pressure Sensors

(F) Rotary Encoders

(G) Connectors/ Sockets

(H) Temperature Controllers

(I) SSRs / Power Controllers

(J) Counters

(K) Timers

(L) Panel Meters

(M) Tacho / Speed / Pulse Meters

(N) Display Units

(O) Sensor Controllers

(P) Switching Mode Power Supplies

(Q) Stepper Motors & Drivers & Controllers

(R) Graphic/ Logic Panels

(S) Field Network Devices

(T) Software